



Installation and Operating Instructions for GXLdp Differential Indicating Pressure Transducer



TABLE OF CONTENTS

Warnings/ General Information.....	4
Keypad Functions & LCD Display.....	5
Menu Functions/Programming.....	6-14
Error Messages.....	15
Display Resolution Table.....	16
Wiring Diagrams.....	17-18
Specifications.....	19
General Dimensions.....	20
Panel Mount Dimensions.....	21
Load Limitation Chart.....	22

WARNING! READ BEFORE INSTALLATION

DESCRIPTION:

The Ashcroft Model GXLdp Differential Indicating Pressure Transducer is to be used with clean, dry, non-corrosive gases. The accuracy is $\pm 0.25\%$ or $\pm 0.50\%$ of Span Terminal Point, and comes standard with a traceable calibration certificate. Both unidirectional (e.g. 0 to +1.0 in. H₂O) and bidirectional (e.g. ± 0.25 in. H₂O) type ranges are available.

GENERAL:

A failure resulting in injury or damage may be caused by excessive overpressure, excessive vibration or pressure pulsation, excessive instrument temperature, corrosion of the pressure containing parts, or other misuse. Consult Ashcroft Inc. Stratford, Connecticut, USA before installing if there are any questions or concerns.

OVERPRESSURE:

Pressure spikes in excess of the rated overpressure capability of the transducer may cause irreversible electrical and/or mechanical damage to the pressure measuring and containing elements.

STATIC ELECTRICAL CHARGES:

Any electrical device may be susceptible to damage when exposed to static electrical charges. To avoid damage to the transducer the operator/installer should follow proper ESD (electrostatic discharge) protection procedures before handling the pressure transducer.

INSTALLATION AND WIRING INSTRUCTIONS

Mounting:

The GXLdp transducer can be mounted on a 35 mm DIN rail or with #8 or #10 screws using the 3 mounting holes provided. Torque limits on the three mounting holes provided is 9.6 inch-pounds. For optional panel mounting information, please refer to page 21.

Electrical Wiring:

To open the housing, push the latch through the opening on the right side of the unit until the front cover releases from the body. Connect wiring to the pluggable/unpluggable terminal block. See wiring diagrams on pages 17-18. Use a screwdriver to tighten after the stripped wire is fully inserted. To close the unit, press the front cover against the rear cover firmly until the latch engages. The use of shielded cable is recommended for optimum performance. Connect the shield to the guard terminal on the reading instrument (meter etc.) if available or to ground.

The GXLdp will automatically detect if a 2-wire or 3-wire power supply has been used to power up the device.

KEYPAD FUNCTIONS AND LCD DISPLAY INFORMATION

Keypad Functions:

Up Arrow

Backlight/Back

SpoolCal® Key

Down Arrow

Menu/Enter

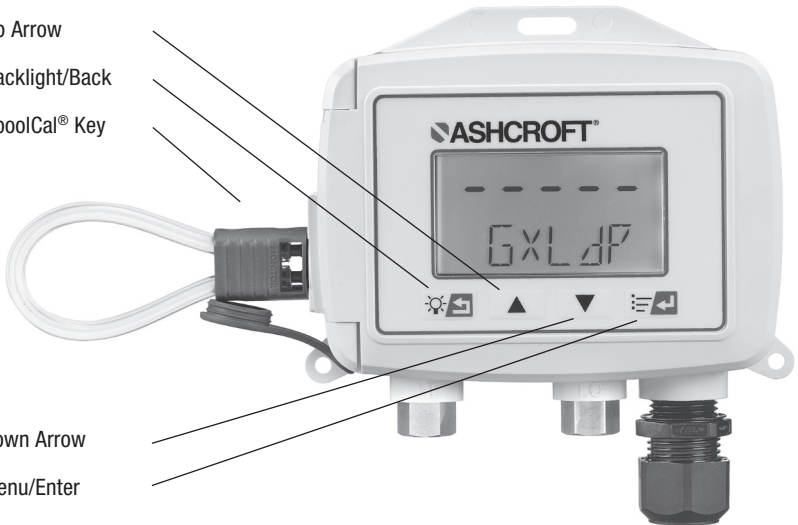

LCD Display Information:

The top (numerical) display portion reads the current pressure range during normal operation.

The lower (alphanumeric) display portion reads the engineering units during normal operation.

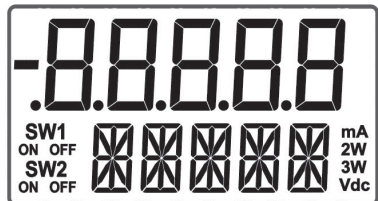

SW1 is present if SW1 (Switch 1) is active. **ON** or **OFF** displays depending on trip status of the switch.

SW2 is present if SW2 (Switch 2) is active. **ON** or **OFF** displays depending on trip status of the switch.

mA or **Vdc** will display depending on the selected Analog Output.

2W or **3W** will display depending on if a 2-wire or 3-wire input power supply is connected to the GXLdp.

MENU FUNCTIONS/PROGRAMMING

Keypad Functions

Backlight/Back



The back button  generally moves back one screen in the menu. The back button also allows you to continue to move back until you return to the main menu if you wish to exit from a specific menu function. This button also allows the user to turn the Backlight function on or off with a (2-second) long button press.

BL ON will flash on the display when the Backlight function is being turned on.





BL OFF will flash on the display when the Backlight function is being turned off. After a couple of seconds, the BL OFF message will disappear from the screen.



Up Arrow Button



The up arrow  generally scrolls up in the menu tree, or performs an adjustment. The up arrow  also allows the user to check the configuration/settings of the GXLdp: Units, Range, Output and Firmware version will all display with a (2-second) long button press.

Please note that only the Analog Output is field selectable and the other parameters are as built at the factory.

If a long button press of the up arrow  occurs, the menu screens will appear as shown below. Each of these parameters will flash on the screen briefly and then disappear.

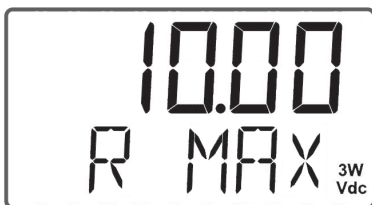
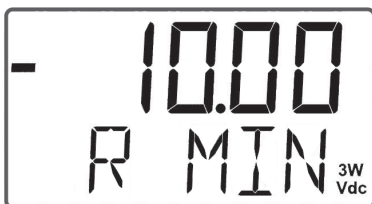
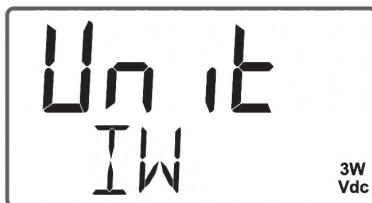

Up Arrow Button (continued)

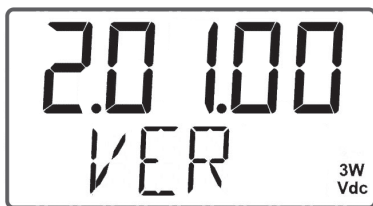



Down Arrow Button



The down arrow ▼ scrolls down in the menu tree.

Menu/Enter



The Menu/Enter button  moves right in the menu tree, if there is an item to the right. If there is no item to the right, the Menu/Enter button  saves the user's changes to (non-volatile) memory and exits the menu tree. This button also allows the user to Zero the unit from the live display with a (2-second) long button press. Press Menu/Enter  with a long button press. The word 'ZERO' will flash briefly. The unit is now zeroed and will then return to the main menu (live pressure readings).

MAIN MENU SELECTIONS:

A OUT – Analog Output: Allows user to choose output signal.

DAMP – Dampening: Allows user to vary the response time of the GXLdp output. The digital display and the analog output are both updated with the use of the DAMP function.

RECAL – Recalibration: Allows user to perform a field calibration of the zero and span setting of the GXLdp.

RESET – Reset: Allows user to reset the GXLdp to its original factory settings.

ZERO – Zero: Allows the user to perform a user zero offset of the GXLdp

SWITC (Optional) – Switch function: Allows the user to enable and set one or two **NPN** or **PNP** switch outputs.

A OUT: Analog Output

Analog Output choices are selectable through the menu.

There are five Analog Outputs to choose from: 4-20 mA, 0-5 Vdc, 0-10 Vdc, 1-5 Vdc, 1-6 Vdc .







- 4-20 mA is designated by 'mA'
- 0-5 Vdc is designated by 'V0-5'
- 0-10 Vdc is designated by 'V0-10'
- 1-5 Vdc is designated by 'V1-5'
- 1-6 Vdc is designated by 'V1-6'

Please note that 4-20 mA output can be powered up by a 2-wire or 3-wire Input Power Supply, while a Voltage output must be powered by a 3-wire Input Power Supply.

If 4-20 mA output is selected and the SWITCH function is activated, the unit requires a 3-wire Input Power Supply. The GXLdp can automatically detect if the input power is a 2-wire or a 3-wire device.

The current Analog Output default can be seen on the digital display of the main menu using one of the designations noted above. A new unit ships with mA (4-20 mA) set as the default.

Field Selection of the Analog Output:

1. To change the Analog Output, press the Menu/Enter button , and scroll through the main menu until 'A OUT' is flashing.
Then press Menu/Enter button  again. The currently selected analog output will be flashing.
2. To keep the output the same, press Menu/Enter  and then while 'SAVE' is flashing, press Menu/Enter  to return to the live display.
3. To change the current Analog Output use the up or down arrow buttons ▲ ▼ until the desired output is flashing and then press Menu/Enter . 'SAVE' will then be flashing. Press Menu/Enter  to save this new selection and then you will return to the live display.
4. If you do not want to save this selection scroll from 'SAVE' to 'CANCL', and while 'CANCL' is flashing, press Menu Enter  and then the unit will return to the live display with no change to the Analog Output setting.



DAMP: Dampening



User can select from four display response times:

- a. 250 ms
- b. 1 sec
- c. 3 sec
- d. 5 sec.

250 ms is the standard factory default.

Modify the 'DAMP' (Dampening) selection in the field:

1. To change the 'DAMP' setting press the Menu/Enter button , and scroll using the up or down arrow buttons ▲ ▼ until 'DAMP' is flashing. Then press the Menu/Enter button .
2. The current 'DAMP' setting will be flashing.

3. Scroll using the up or down arrow buttons ▲ ▼ until the desired dampening time is flashing. Then press Menu/Enter . Then 'SAVE' will be flashing. Press Menu/Enter  to save the new DAMP setting. The unit will then revert to live pressure readings.
4. If you do not want to save the new 'DAMP' setting, scroll using the up or down arrow buttons ▲ ▼ until 'CANCL' is flashing. Press Menu/Enter . The DAMP setting will not be changed from the previous setting and the display will revert to live pressure readings.

RECAL: Re-Calibration

The 'RECAL' function in the GXLdp menu provides the user the ability to field calibrate the product. The most recent factory calibration is permanently retained in memory and can be recalled at any time. Both zero and span adjustments are made through the menu.

When a factory new GXLdp is being re-calibrated for the first time in the field, you will have the following options:

1. **FACT** – reverts to the original Factory Calibration settings.
2. **NEW** – allows the user to perform a new Calibration in the field.





After the GXLdp has been re-calibrated at least once in the field, you will have the following options:

1. **FACT** – reverts to the original Factory Calibration settings.
2. **NEW** – allows the user to perform a new Calibration in the field.
3. **FIELD** – reverts to the most recently performed Field Calibration.

Factory Calibration (FACT)





Enter Factory Calibration to reset the unit to its most recent factory calibration parameters.



1. Press the Menu/Enter button  and

- scroll using the up or down arrow buttons ▲ ▼ until 'RECAL' is flashing on the display. Then press Menu/Enter  again.
- Then the menu choices will be FACT/ FIELD/NEW. Press the up or down arrow buttons ▲ ▼ until 'FACT' is flashing on the display.
 - When 'FACT' is flashing on the display, press the Menu/Enter button .
 - Then with 'SAVE' flashing on the display press the Menu/Enter button .
 - This will restore the most recent factory calibration.
 - If 'SAVE' is flashing and you do not wish to 'SAVE' the factory calibration, use the up or down arrow buttons ▲ ▼ to scroll to 'CANCL' and while 'CANCL' is flashing on the display, press Menu/Enter  which will return you to the main menu.

New Field Calibration (NEW)



Enter New Field Calibration if you wish to perform a field calibration of the GXLdp.



- Press the Menu/Enter button  and scroll using the up or down arrow buttons ▲ ▼ until 'RECAL' is flashing on the display. Press the Menu/Enter Button .
- There will be three menu choices FACT/ FIELD/NEW. Scroll using the up or down arrow buttons ▲ ▼ until 'NEW' is flashing.
- When 'NEW' is flashing on the display, press the Menu/Enter Button .
- 'ADJST/ZERO' will now be flashing on the display. This will allow you to calibrate the Zero value for the GXLdp.
- Apply zero pressure to the Hi and Lo ports of the GXLdp. This can be best accomplished by shorting the HI and LO ports on the GXLdp.
- Using the up or down arrow buttons ▲ ▼ scroll until the display reads zero. Then press the Menu/Enter button . The unit is now zeroed.

- 'ADJST/SPAN' will now be flashing on the display.
- You will need an external reference pressure source to adjust the span setting.
- Connect tubing from the reference pressure source to both the Hi and Lo pressure ports of the GXLdp.
- Using the external reference pressure source, increase the pressure to the full-scale value of the GXLdp. Then scroll using the up or down arrow buttons ▲ ▼ until the display reads the same as the pressure reference. Note: Span can be adjusted between 90% and 100% of the full scale value.
- Press the Menu/Enter button .
- The menu will now flash 'SAVE' on the display. If you wish to save the NEW calibration, press the Menu/Enter button .
- If you do not want to save the NEW calibration, use the up or down arrow buttons ▲ ▼ to scroll from SAVE to CANCL. With 'CANCL' flashing on the display press the Menu/Enter button . This will return the GXLdp to the main menu and the NEW calibration will not be saved. The unit will maintain its most recent calibration.
- Once you have finished a NEW calibration, this will be stored as the FIELD Calibration.

Field Calibration (FIELD)

Enter Field Calibration if you wish to recover the most recent field calibration values stored in the GXLdp.





- Press the Menu/Enter button  and scroll using the up or down arrow buttons ▲ ▼ until 'RECAL' is flashing on the display. Then press Menu/Enter  again.
- Then the menu choices will be FACT/ FIELD/NEW. Press the up or down arrow buttons ▲ ▼ until 'FIELD' is flashing on the display.

3. When 'FIELD' is flashing on the display, press the Menu/Enter button .
4. Then with 'SAVE' flashing on the display press the Menu/Enter button .
5. This will restore the most recent field calibration.
6. If 'SAVE' is flashing and you do not wish to 'SAVE' the field calibration, use the up or down arrow buttons ▲ ▼ to scroll to 'CANCL' and while 'CANCL' is flashing on the display, press Menu/Enter  which will return you to the main menu.

RESET:



This will allow the user to revert to all menu settings as shipped from the factory. This includes: Analog Output, Switch settings (if option is applicable), Damping, and User Zero. This will also clear any saved Field Calibration from memory and reset the GXLdp to the Factory Calibration.

To perform the RESET procedure:

1. Press Menu/Enter  and scroll using the up or down arrows ▲ ▼ until 'RESET' is flashing. Then press Menu/Enter .
2. 'SAVE' will now be flashing on the display. If you wish to restore all factory default settings, press Menu/Enter  while 'SAVE' is flashing on the display. The unit will then return to the main menu and all factory settings will be re-stored including FACTORY Calibration.
3. If you do not want to restore all factory default settings, scroll using the up or down arrow keys ▲ ▼ until 'CANCL' is flashing on the display, and then press Menu/Enter . The unit will return to the main menu and no settings will be changed.

ZERO (Zeroing function)

In addition to being able to Zero from the live display, the user can also Zero the unit through the Menu.

1. Press Menu/Enter  and scroll using the up or down arrows ▲ ▼ until 'ZERO' is flashing on the display.
2. Press Menu/Enter  and then while 'SAVE' is flashing press Menu/Enter  again. This will zero the unit, and return to live pressure readings.

OPTIONAL FEATURES:

SWITC: Switch function

The GXLdp is available with an optional switch function. If ordered this feature will allow the user to choose between 1 or 2 PNP or NPN switches as well as allowing the user to choose the set and reset point of each switch.





If the user chooses to use two switches, they must be the same type, either PNP or NPN.







NOTE:

To set an Increasing set point, the reset value must be lower than the set point

To set a Decreasing set point, the reset value must be higher than the set point

To enable and set the switch feature

1. To enable the optional switch, press the Menu/Enter button , and scroll through the main menu using the up or down arrow buttons ▲ ▼ until 'SWITC' is flashing. Then press Menu/Enter button  again.
2. Initially, PNP will be flashing on the display, and you can change the switch type to NPN by pressing the up or down arrow buttons ▲ ▼
3. Once you are on the desired switch type press the Menu/Enter button .
4. Initially, SW1 DISAB will be flashing on the display. Press the up or down arrow buttons ▲ ▼ until SW1 ENABL is flashing on the display. Then press the Menu/Enter button .

5. SW1SP will be flashing on the display. This will allow the user to calibrate the SW1 (Switch 1) set point.
6. Press the Up arrow ▲, this will cause the first digit to flash.
7. If you wish to change this digit press the up or down arrow buttons ▲ ▼ (NOTE: for Bidirectional ranges you can set the switch for a negative set point, this will be designated by a minus sign showing in front of the set point on the display).
8. Once you adjust the digit to the appropriate number, press the Menu/Enter button  to get to the next digit.
9. Repeat steps 7 & 8 until all 5 digits are displaying correctly. While the last digit is flashing, press the Menu/Enter button . Then SW1SP will be flashing on the display. Press the Menu/Enter button  again.
10. SW1RS will be flashing on the display. This will allow the user to calibrate the Switch 1 reset point.
11. Press the Up arrow ▲, this will cause the first digit to flash.
12. To change this digit press the up or down arrow buttons ▲ ▼ (NOTE: for Bidirectional ranges you can set the switch for a negative set point, this will be designated by a minus sign showing in front of the set point on the display).
13. Once you adjust the digit to the appropriate number, press the Menu/Enter button  to get to the next digit.
14. Repeat steps 12 & 13 until all 5 digits are displaying correctly. While the last digit is flashing, press the Menu/Enter button . Then SW1RS will be flashing on the display. Press the Menu/Enter button  again. SW1 setup is now complete.
15. Then SW2 DISAB will flash on the display. If you also want to enable switch

two (SW2) repeat steps 4 through 14 to setup SW2. If you do not wish to enable SW2, simply press the Menu/Enter button  while SW2 DISAB is flashing.

16. SAVE will flash on the display. Press the Menu/Enter button  to save the settings for both SW1 and SW2. The display will return to the main menu.

NOTE: Once you have completed the set up for the SWITCH (SWITC) function, any enabled switch is indicated in the lower left portion of the display. If SW1 or SW2 are energized the display will show ON under the appropriate switch, if SW1 or SW2 are de-energized the display will show OFF under the appropriate switch.

SpoolCal® (XPV):

The rotating process valve actuator in conjunction with the SpoolCal® actuator tool provides two types of available tests including Calibrate (CAL) and Monitor (MONITOR) through the appropriate Hi and Lo Port of the SpoolCal® actuator tool. In the CAL (Calibrate) mode, the GXLdp is isolated from the process and allows externally generated test pressure input for calibration. In the MONITOR (Monitor) mode, the live system pressure can be monitored with an ASHCROFT ATE-2 Calibrator or other handheld instrument without physically unplugging the process tubes. The "XPV" option supplies a SpoolCal® actuator and 7' of silicon tubing. The actuator tool can be set to either CAL (Calibrate mode), MONITOR (Monitor mode) or OFF, and also includes HI (high) and LO (low) differential pressure ports.

GXLdp SPOOLCAL® OPERATION

From the 'OFF' position, the SpoolCal® actuator tool can be inserted and removed. Rotate the actuator tool 90° clockwise for Calibration mode (CAL) or 90° counter clockwise for Monitor mode (MONITOR)

**ROTATE KEY 90°
CLOCKWISE TO
(CAL) POSITION**

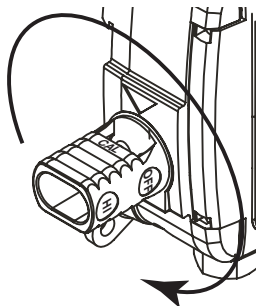

OFF POSITION

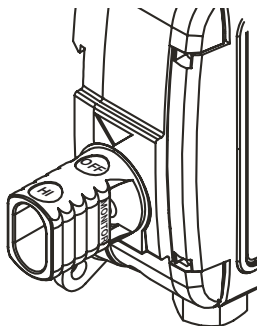

**ROTATE KEY 90°
COUNTER CLOCKWISE TO
(MONITOR) POSITION**

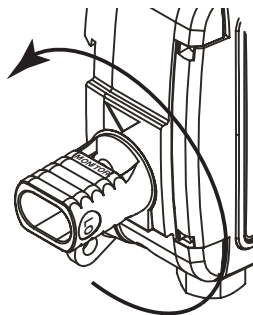

Calibration (CAL):

Both zero and span adjustments are made through the menu. (For complete calibration details of the GXLdp without using the Spool Cal option, refer to the RECAL section- page 8). A 90-degree clockwise rotation of the SpoolCal key places the unit into 'CAL' mode, this isolates the GXLdp from the process pressure.

The RECAL function in the GXLdp menu provides the user the ability to field calibrate the product. The most recent factory calibration is permanently retained in memory and can be recalled at any time.





Once you enter the Re-Calibration (RECAL) Mode you will have the following options:

1. **FACT** – Factory Calibration
2. **NEW** – New Field Calibration
3. **FIELD** – Field Calibration

Note: On initial calibration, Field Calibration will not show in the menu. To perform the initial field calibration you will choose New (New Field Calibration). Once you have saved the New Calibration, Field Calibration will appear the next time you enter Calibration Mode.

Factory Calibration (FACT)





Enter Factory Calibration to reset the unit to its most recent factory calibration parameters.



1. Press the Menu/Enter button  and scroll using the up or down arrow buttons ▲ ▼ until 'RECAL' is flashing on the display. Then press Menu/Enter  again.
2. Then the menu choices will be FACT/FIELD/NEW. Press the up or down arrow buttons ▲ ▼ until 'FACT' is flashing on the display.
3. When 'FACT' is flashing on the display, press the Menu/Enter button .
4. Then with 'SAVE' flashing on the display press the Menu/Enter button .
5. This will restore the most recent factory calibration.

6. If 'SAVE' is flashing and you do not wish to 'SAVE' the factory calibration, use the up or down arrow buttons ▲ ▼ to scroll to 'CANCL' and while 'CANCL' is flashing on the display, press Menu/Enter  which will return you to the main menu.

New Field Calibration (NEW):





Enter New Field Calibration if you wish to perform a field calibration of the GXLdp.

1. Press the Menu/Enter button  and scroll using the up or down arrow buttons ▲ ▼ until 'RECAL' is flashing on the display. Press the Menu/Enter Button .
2. There will be three menu choices FACT/FIELD/NEW. Scroll using the up or down arrow buttons ▲ ▼ until 'NEW' is flashing.
3. When 'NEW' is flashing on the display, press the Menu/Enter Button .
4. 'ADJST/ZERO' will now be flashing on the display. This will allow you to calibrate the Zero value for the GXLdp.
5. Apply zero pressure to the Hi and Lo ports. This can be best accomplished by shorting the HI and LO ports on the SpoolCal™ actuator tool using the silicon tubing supplied.
6. Using the up or down arrow buttons ▲ ▼ scroll until the display reads zero. Then press the Menu/Enter button . The unit is now zeroed.
7. 'ADJST/SPAN' will now be flashing on the display.
8. Remove the silicone tubing from the SpoolCal™ actuator tool.
9. You will need an external pressure source to adjust the span setting.
10. Connect tubing from the pressure source to both the Hi and Lo pressure ports of the SpoolCal™ actuator tool.
11. Using the external pressure source, increase the pressure to the full-scale value of the GXLdp. Then scroll using the up or down arrow buttons ▲ ▼ until the display reads the same as the pressure reference.

12. Press the Menu/Enter button .
13. The menu will now flash 'SAVE' on the display. If you wish to save the NEW calibration, press the Menu/Enter button .
14. If you do not want to save the NEW calibration, use the up or down arrow buttons ▲ ▼ to scroll from SAVE to CANCL. With 'CANCL' flashing on the display press the Menu/Enter button . This will return the GXLdp to the main menu and the unit will maintain its most recent calibration.
15. Once you have finished a NEW calibration, this will be stored as the FIELD Calibration.

Field Calibration (FIELD):

Enter Field Calibration if you wish to recover the most recent field calibration values stored in the GXLdp.

1. Press the Menu/Enter button  and scroll using the up or down arrow buttons ▲ ▼ until 'RECAL' is flashing on the display. Then press Menu/Enter  again.
2. Then the menu choices will be FACT/FIELD/NEW. Press the up or down arrow buttons ▲ ▼ until 'FIELD' is flashing on the display.
3. When 'FIELD' is flashing on the display, press the Menu/Enter button .
4. Then with 'SAVE' flashing on the display press the Menu/Enter button .
5. This will restore the most recent field calibration.
6. If 'SAVE' is flashing and you do not wish to 'SAVE' the field calibration, use the up or down arrow buttons ▲ ▼ to scroll to 'CANCL' and while 'CANCL' is flashing on the display, press Menu/Enter  which will return you to the main menu.

Monitor (MONITOR):

While in 'MONITOR' (Monitor) mode, the GXLdp can provide the (live) system pressure measurement without having to physically unplug the process tubes. Insert the SpoolCal[®] actuator tool into the side of the GXLdp, while the SpoolCal[®] is in the 'OFF' position. A 90-degree counterclockwise rotation tee's the process to both the GXLdp unit and out through the SpoolCal[®] actuator tool, and provides external measurement capability with the use of a portable instrument such as the Ashcroft ATE-2. Connect the tubing from the portable instrument to both the high and low pressure port of the SpoolCal[®] actuator tool. The user can then verify (live) system pressure readings.

GXLdp Error Messages

Note: Multiple Errors may be displayed.

Err02	Configuration Error. Mismatch between sensor serial number on the sensor board and the sensor serial number recorded on the display board. FATAL ERROR.
Err03	Calibration Error. Device has not been factory calibrated or the factory calibration data is corrupt. FATAL ERROR.
Err04	Settings Error. User Settings (Menu settings) are corrupt. FATAL ERROR.
Err05	Communication Error. Pressure sensor has stopped working. FATAL ERROR.
Err06	3-Wire Power Error. Voltage output is selected, but there is no external power. This may be field correctable.
Err07	Range data missing or corrupt. FATAL ERROR
LIMIT	LIMIT will display if the user tries to Zero more than 5% of Span. LIMIT will also display if the user tries to adjust Span by more than 5% of the positive full-scale value.
OVER	OVER will display if the unit is Over-Pressured.
S LOC	S LOC will display if the user attempts to make a span adjustment at less than 90% of the positive full-scale value.
UNDER	UNDER will display if the unit is Under-Pressured.
Z LOC	Z LOC will display if the user attempts to make a zero offset adjustment while outside of Zero $\pm 10\%$ of positive full-scale.

GXLdp Display Resolution Table

in. H₂O Unidirectional	MIN	MAX	in. H₂O Bidirectional	MIN	MAX
0.10 in. H ₂ O	0.0000	0.1000	(±) 0.05 in. H ₂ O	-0.0500	0.0500
0.20 in. H ₂ O	0.0000	0.2000	(±) 0.10 in. H ₂ O	-0.1000	0.1000
0.25 in. H ₂ O	0.0000	0.2500	(±) 0.25 in. H ₂ O	-0.2500	0.2500
0.40 in. H ₂ O	0.0000	0.4000	(±) 0.50 in. H ₂ O	-0.5000	0.5000
0.50 in. H ₂ O	0.0000	0.5000	(±) 1.00 in. H ₂ O	-1.0000	1.0000
0.60 in. H ₂ O	0.0000	0.6000	(±) 2.00 in. H ₂ O	-2.0000	2.0000
0.75 in. H ₂ O	0.0000	0.7500	(±) 2.50 in. H ₂ O	-2.5000	2.5000
1.00 in. H ₂ O	0.0000	1.0000	(±) 3.00 in. H ₂ O	-3.0000	3.0000
2.00 in. H ₂ O	0.0000	2.0000	(±) 5.00 in. H ₂ O	-5.0000	5.0000
2.50 in. H ₂ O	0.0000	2.5000	(±) 8.00 in. H ₂ O	-8.0000	8.0000
3.00 in. H ₂ O	0.0000	3.0000	(±) 10.00 in. H ₂ O	-10.0000	10.0000
5.00 in. H ₂ O	0.0000	5.0000	(±) 15.00 in. H ₂ O	-15.0000	15.0000
10.00 in. H ₂ O	0.0000	10.0000	(±) 25.00 in. H ₂ O	-25.0000	25.0000
15.00 in. H ₂ O	0.0000	15.0000			
20.00 in. H ₂ O	0.0000	20.0000			
25.00 in. H ₂ O	0.0000	25.0000			
Pa Unidirectional	MIN	MAX	Pa Bidirectional	MIN	MAX
25 Pa	0.00	25.00	(±) 15 Pa	-15.00	15.00
50 Pa	0.00	50.00	(±) 25 Pa	-25.00	25.00
60 Pa	0.00	60.00	(±) 30 Pa	-30.00	30.00
100 Pa	0.00	100.00	(±) 50 Pa	-50.00	50.00
125 Pa	0.00	125.00	(±) 60 Pa	-60.00	60.00
160 Pa	0.00	160.00	(±) 100 Pa	-100.00	100.00
200 Pa	0.00	200.00	(±) 125 Pa	-125.00	125.00
250 Pa	0.00	250.00	(±) 160 Pa	-160.00	160.00
300 Pa	0.00	300.00	(±) 200 Pa	-200.00	200.00
400 Pa	0.00	400.00	(±) 300 Pa	-300.00	300.00
500 Pa	0.00	500.00	(±) 400 Pa	-400.00	400.00
600 Pa	0.00	600.00	(±) 500 Pa	-500.00	500.00
1.00 kPa	0.0000	1.0000	(±) 600 Pa	-600.00	600.00
1.60 kPa	0.0000	1.6000	(±) 1.0 kPa	-1.0000	1.0000
2.00 kPa	0.0000	2.0000	(±) 1.25 kPa	-1.2500	1.2500
2.50 kPa	0.0000	2.5000	(±) 1.6 kPa	-1.6000	1.6000
4.00 kPa	0.0000	4.0000	(±) 2.00 kPa	-2.0000	2.0000
5.00 kPa	0.0000	5.0000	(±) 2.50 kPa	-2.5000	2.5000
6.00 kPa	0.0000	6.0000	(±) 4.00 kPa	-4.0000	4.0000
			(±) 5.00 kPa	-5.0000	5.0000
mb Unidirectional	MIN	MAX	mb Bidirectional	MIN	MAX
0.25 mb	0.0000	0.2500	(±) 0.15 mb	-0.1500	0.1500
0.50 mb	0.0000	0.5000	(±) 0.25 mb	-0.2500	0.2500
0.60 mb	0.0000	0.6000	(±) 0.30 mb	-0.3000	0.3000
1.00 mb	0.0000	1.0000	(±) 0.50 mb	-0.5000	0.5000
1.25 mb	0.0000	1.2500	(±) 0.60 mb	-0.6000	0.6000
1.60 mb	0.0000	1.6000	(±) 1.00 mb	-1.0000	1.0000
2.00 mb	0.0000	2.0000	(±) 1.25 mb	-1.2500	1.2500
2.50 mb	0.0000	2.5000	(±) 1.60 mb	-1.6000	1.6000
3.00 mb	0.0000	3.0000	(±) 2.00 mb	-2.0000	2.0000
4.00 mb	0.0000	4.0000	(±) 3.00 mb	-3.0000	3.0000
5.00 mb	0.0000	5.0000	(±) 4.00 mb	-4.0000	4.0000
6.00 mb	0.0000	6.0000	(±) 5.00 mb	-5.0000	5.0000
10.00 mb	0.0000	10.0000	(±) 6.00 mb	-6.0000	6.0000
16.00 mb	0.0000	16.0000	(±) 10.00 mb	-10.0000	10.0000
20.00 mb	0.0000	20.0000	(±) 12.50 mb	-12.5000	12.5000
25.00 mb	0.0000	26.0000	(±) 16.00 mb	-16.0000	16.0000
40.00 mb	0.0000	40.0000	(±) 20.00 mb	-20.0000	20.0000
50.00 mb	0.0000	50.0000	(±) 25.00 mb	-25.0000	25.0000
60.00 mb	0.0000	60.0000	(±) 40.00 mb	-40.0000	40.0000
			(±) 50.00 mb	-50.0000	50.0000

GXLdp Wiring Diagrams

2 Wire 4-20 mA Output **V+** **V-** **Vout** **EXT** **S1** **S2**

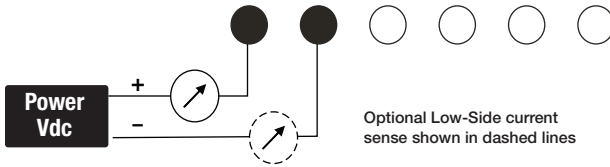

3 Wire 4-20 mA Output **V+** **V-** **Vout** **EXT** **S1** **S2**

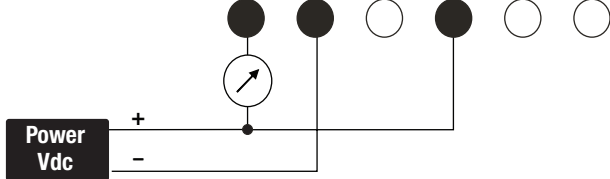

3 Wire 4-20 mA Output With PNP Switches

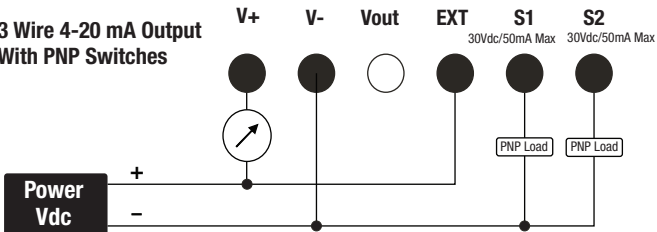

3 Wire 4-20 mA Output With NPN Switches

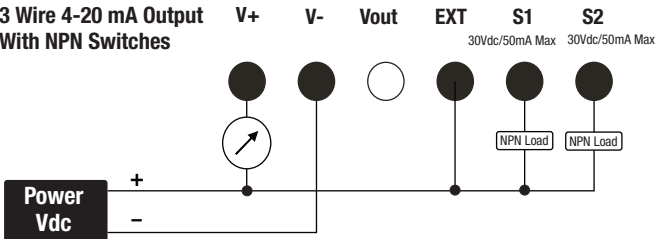

GXLdp Wiring Diagrams

3 Wire Voltage Output

V+ V- Vout EXT S1 S2

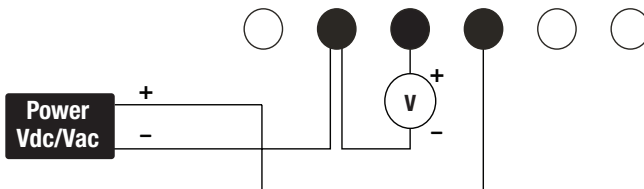

3 Wire Voltage Output With NPN Switches

V+ V- Vout EXT S1 S2
30Vdc/50mA Max 30Vdc/50mA Max

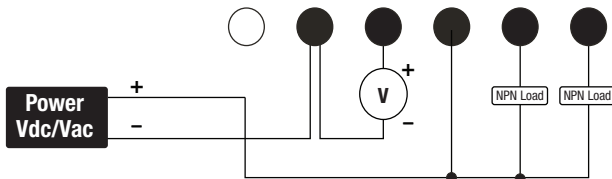

3 Wire Voltage Output with PNP Switches

V+ V- Vout EXT S1 S2
30Vdc/50mA Max 30Vdc/50mA Max

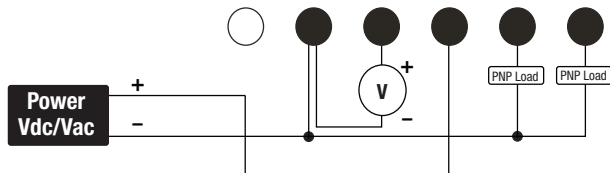

GXLdp SPECIFICATIONS

Accuracy:

±0.25% or ±0.50% of Span, Terminal Point Method

Range Capability (Unidirectional):

0.1 in. H₂O through 25 in. H₂O, 25 Pa through 6 kPa, 0.25 mb through 60 mb

Range Capability (Bidirectional):

±0.05 in. H₂O through ±25 in. H₂O, ±15 Pa through ±5 kPa, ±0.15 mb through ±50 mb

Adjustable Display Response Time Dampening): 250 ms, 1 sec, 3 sec, 5 sec

Temperature Limits:

Storage: -22 °F to 158 °F (-30 °C to 70 °C)
Operating: -4 °F to 158 °F (-20 °C to 70 °C)
Compensated: 35 °F to 130 °F (1.6 °C to 54 °C)

Max. Static (Line) Pressure: 25 psid

Proof Pressure: 15 psid

Burst Pressure: 25 psid

Zero Adjustment:

±5% of span (accessible through menu)

Span Adjustment:

±5% of full scale value (accessible through menu)

Field Selectable Output Signals:

Current:

4-20 mA (2-wire or 3-wire) with Supply Voltage: 12-40 Vdc (24 Vdc typical)

Voltage:

0-5 Vdc, 0-10 Vdc, 1-5 Vdc, 1-6 Vdc (all 3-wire) with Supply Voltage: 12-40 Vdc or 24 Vac(± 20%) (24 Vdc/Vac typical)

Reverse polarity and mis-wire protected:

LCD Display: 3-5 digits:

The resolution/decimal place is fixed based on the range and is not field changeable. See display resolution chart on Page 16

LCD Screen Dimensions:

2.63" Width x 1.38" Height

LCD Character Size:

7-segment (Numeric display):

0.32" Width x 0.65" Height

14-segment (Alphanumeric display) :

0.28" Width x 0.49" Height

Pressure Connection:

1/8 NPT Female, 1/4" Barbed Male, 3/16" Barbed Male

Electrical Connection:

1/2 NPT Female Conduit Connection / PG9 Watertight Cable Gland included.

Electrical connections made to a pluggable terminal block which accepts 18-24 AWG wires.

Enclosure Rating:

UL 94-V0 Flame-retardant ABS, IP67/Nema 4

Process Media:

The GXLdp is designed to measure clean, dry non-corrosive gases. Not for use with liquids.

Weight: 0.8 lbs

Mounting:

Din Rail/ Wall Mount standard, optional Panel Mount

Optional Switch Feature:

Two independent switch outputs, NPN or PNP. Field Programmable -set and reset points. (See detailed description on Pages 10-11)

Optional SpoolCal® Actuator:

(See detailed description on Pages 11-14)

GXLdp GENERAL DIMENSIONS

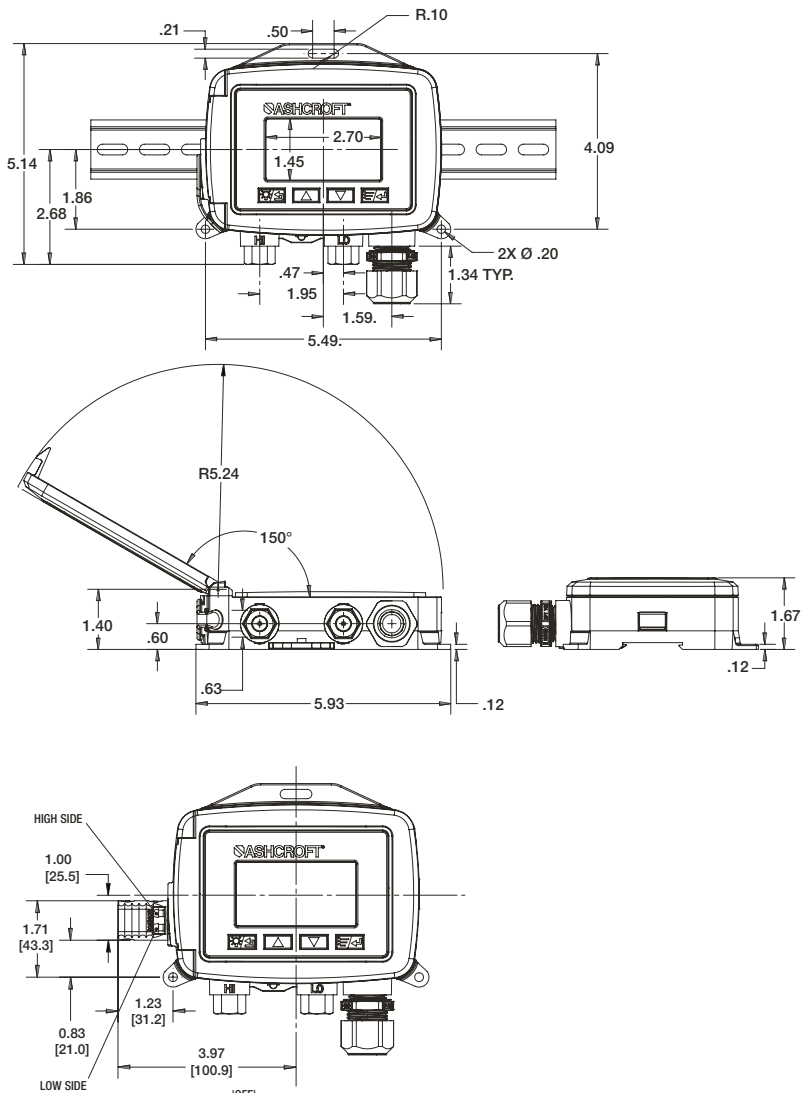

GXLdp PANEL MOUNTING INSTRUCTIONS & DIMENSIONS

To install the unit to the panel mounting:

1. Make a cutout 7" minimum vertical x 5.9" minimum horizontal in your panel or mounting location.
2. Provide (4) 6-32 threaded holes as shown in the drawings below.
3. Place 3 spacers between the unit and the panel mount adapter and insert 6-32 x 1½" screws from the back side of the unit and thread them into the panel mount adapter as shown in the drawings below.
4. Mount to the panel using provided (4) 6-32 x ½" length screws.

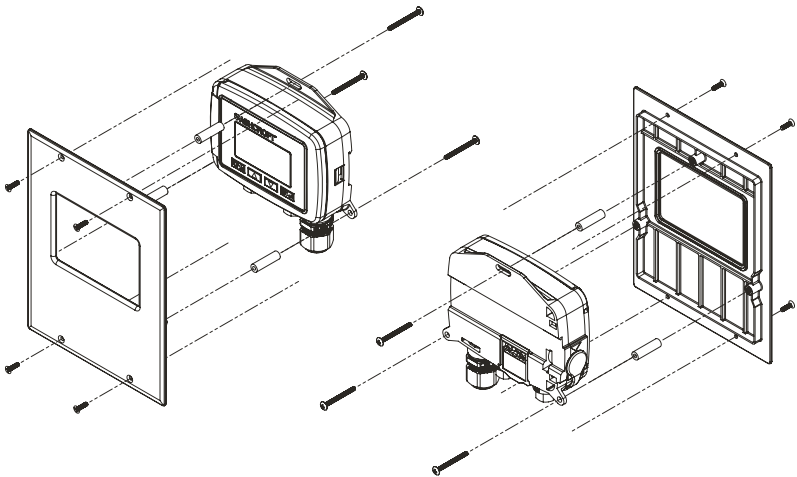
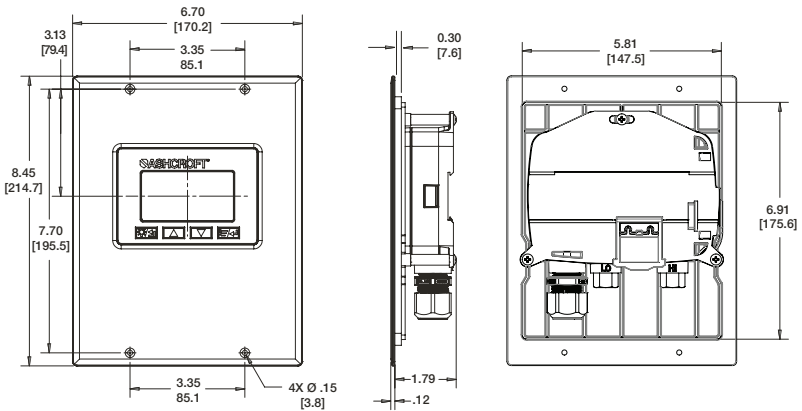

LOAD LIMITATION GRAPH

Load Limitations 4-20 mA Output Only

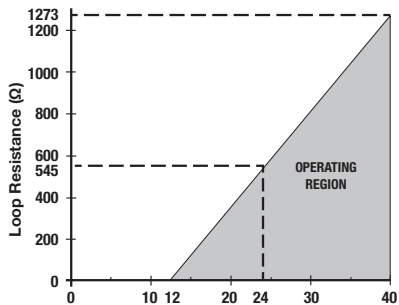

$$V_{\text{MIN}} = 12V + [0.022A \times (R_L)]$$

(*includes a 10% safety factor)

$$R_L = R_S + R_W$$

R_L = Loop Resistance (Ohms)

R_S = Sense Resistance (Ohms)

R_W = Wire Resistance (Ohms)

